

VILLAGE 2  
SEE SHEET PG-2

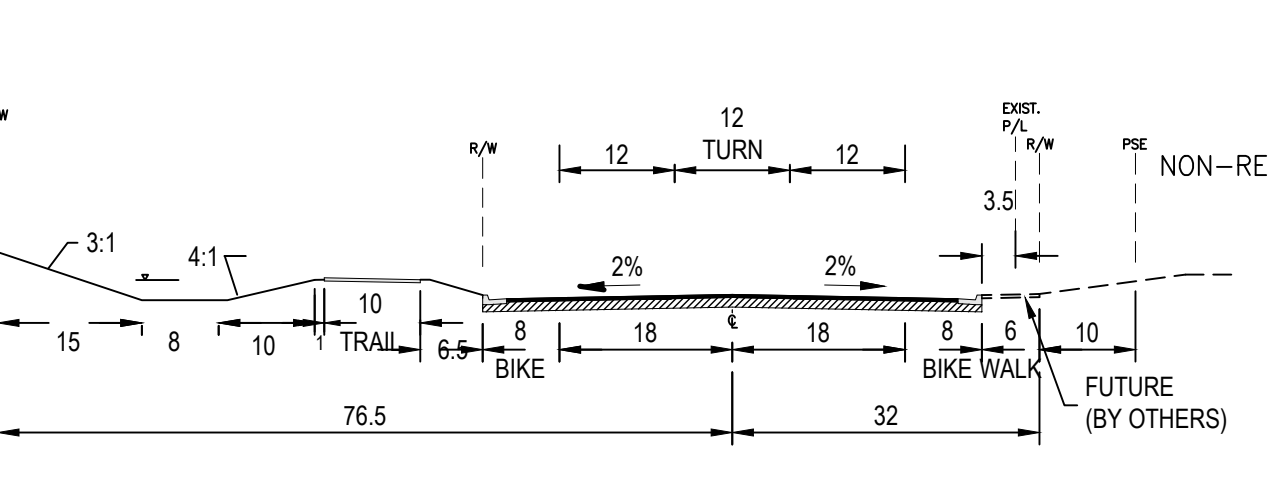

LEGEND

SYMBOLS:		DESCRIPTION
EXISTING	PROPOSED	
		STORM DRAIN PIPE & SIZE
		MANHOLE
		STORM DRAIN INLET
		RIDGE OR GRADE BREAK
		DIRECTION OF DRAINAGE
		FLOWLINE OF SWALE
		RETAINING WALL
		SOUND WALL
		PAD
		6.5' MAX (H)

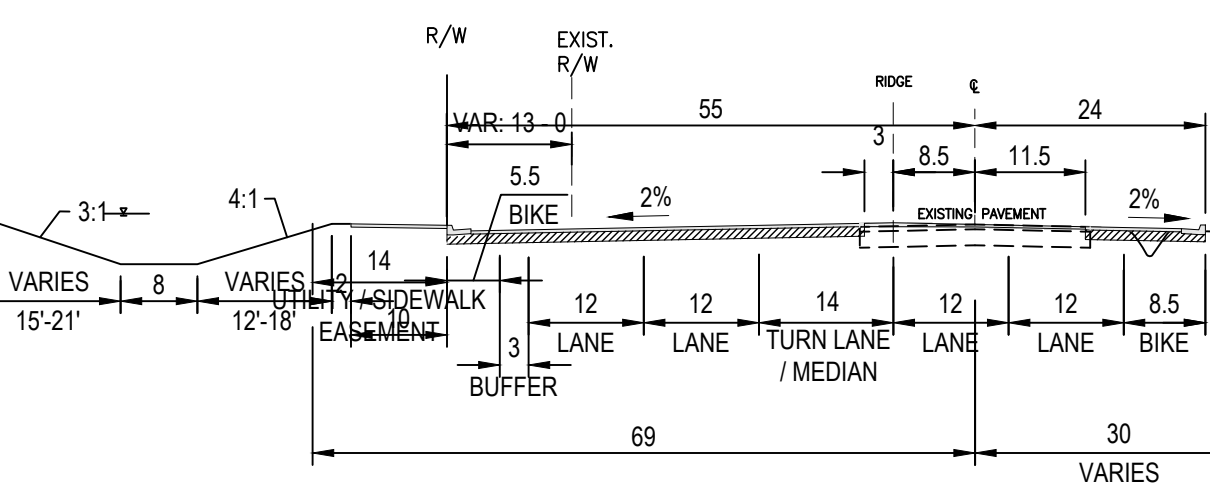
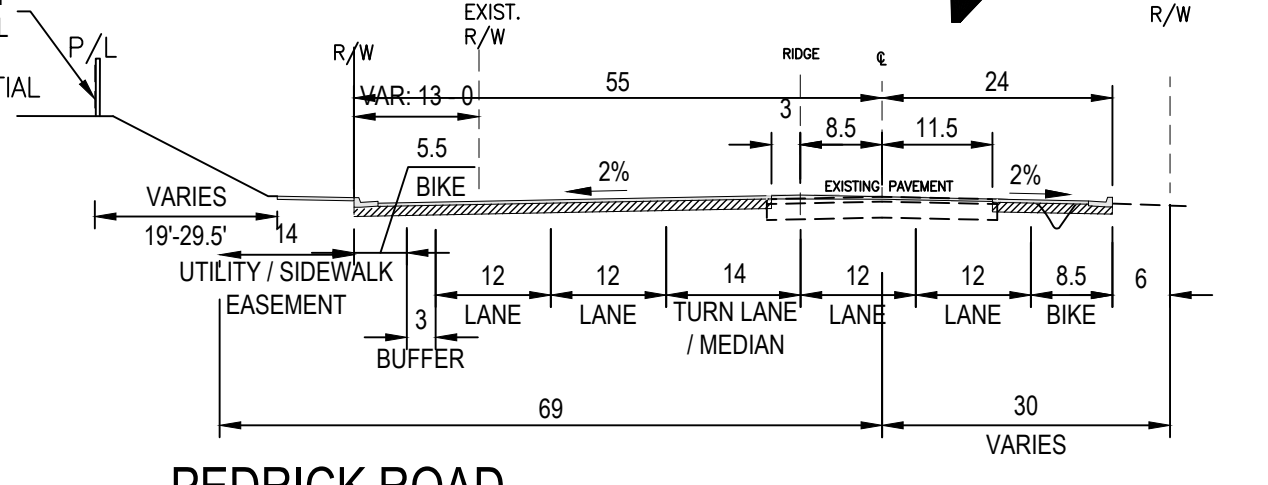
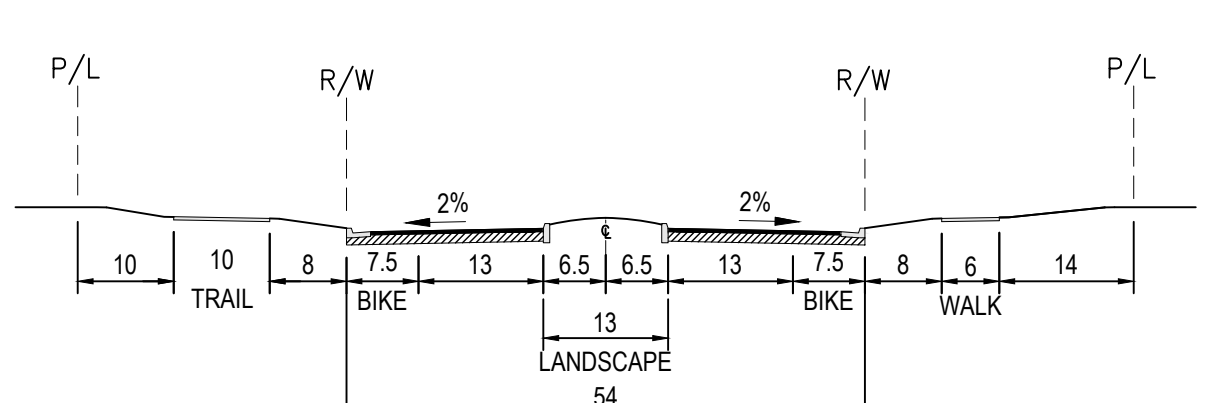
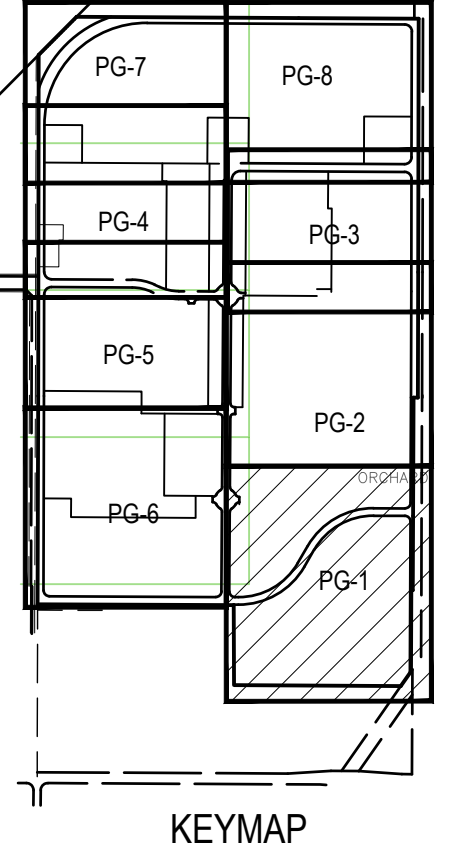
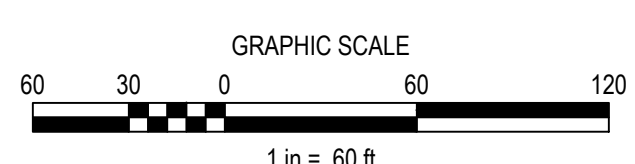
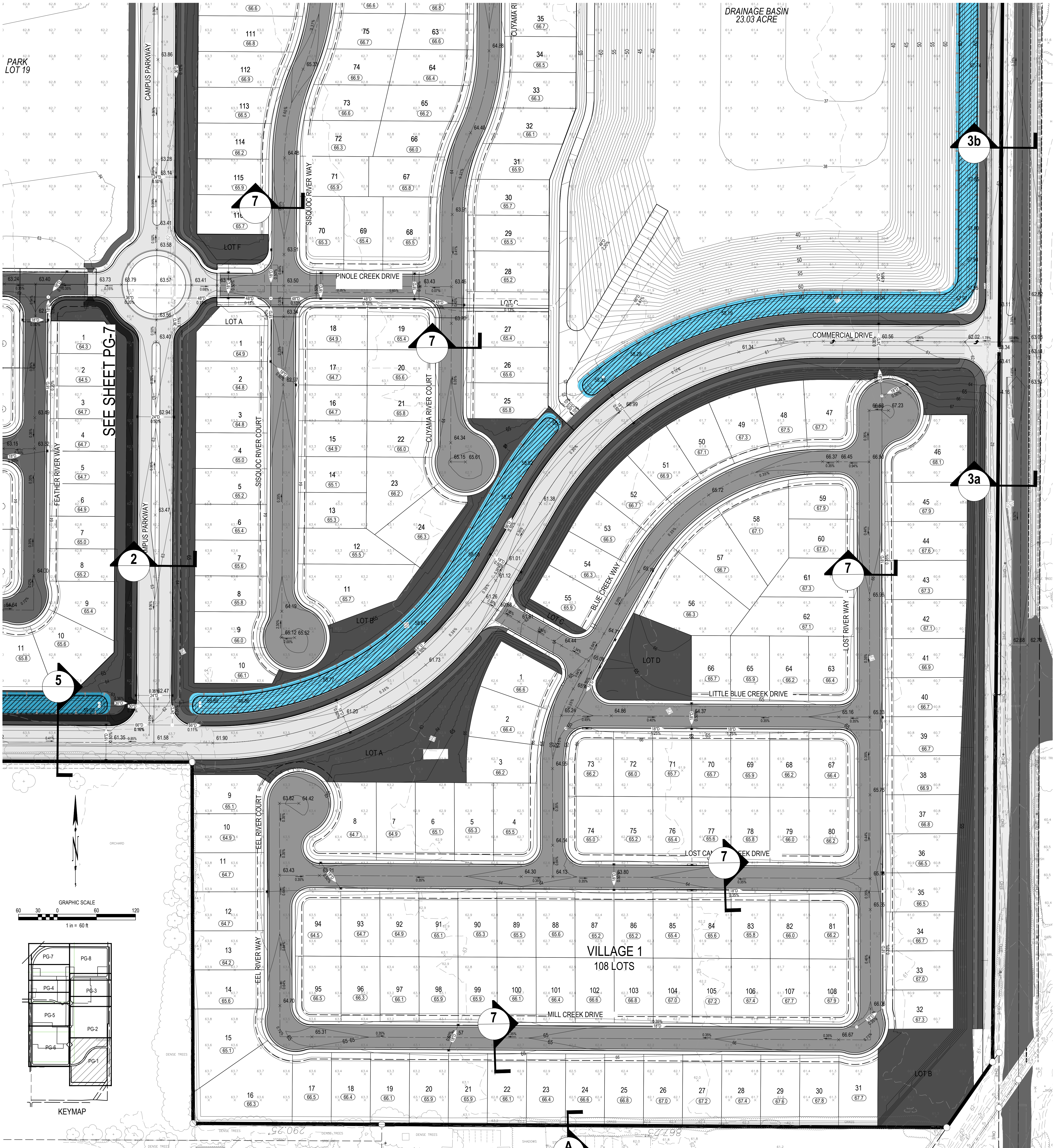
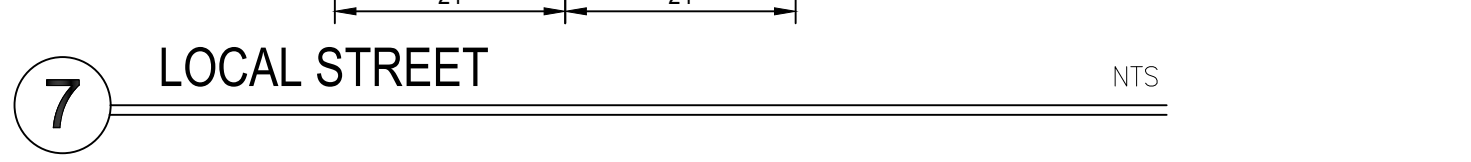

SCALE: 1" = 60'  
 HORIZ. 1" =  
 VERT. 1" =

COMPUTED  
 DESIGNED  
 DRAWN  
 PROJ. ENGR.



**MORTON & PITALO, INC.**  
 CIVIL ENGINEERING • LAND PLANNING • LAND SURVEYING  
 Folsom • Fresno  
 600 Coolidge Drive, Suite #140  
 Folsom, CA 95630  
 phone: (916) 964-7621  
 web: www.mpeinc.com

MAGNA PARCEL-DIXON  
 VILLAGE 1 - PRELIMINARY GRADING

DATE: 3/11/2025  
 SHEET: PG-1  
 OF: 8



VILLAGE 3  
SEE SHEET PG-3



VILLAGE 1  
SEE SHEET PG-1

**LEGEND**

EXISTING	PROPOSED	DESCRIPTION
		STORM DRAIN PIPE & SIZE
		MANHOLE
		STORM DRAIN INLET
		RIDGE OR GRADE BREAK
		DIRECTION OF DRAINAGE
		FLOWLINE OF SWALE

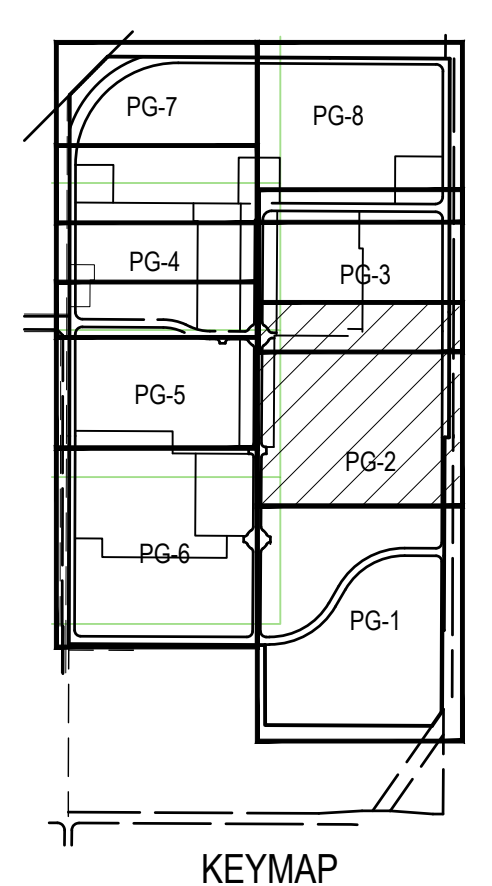
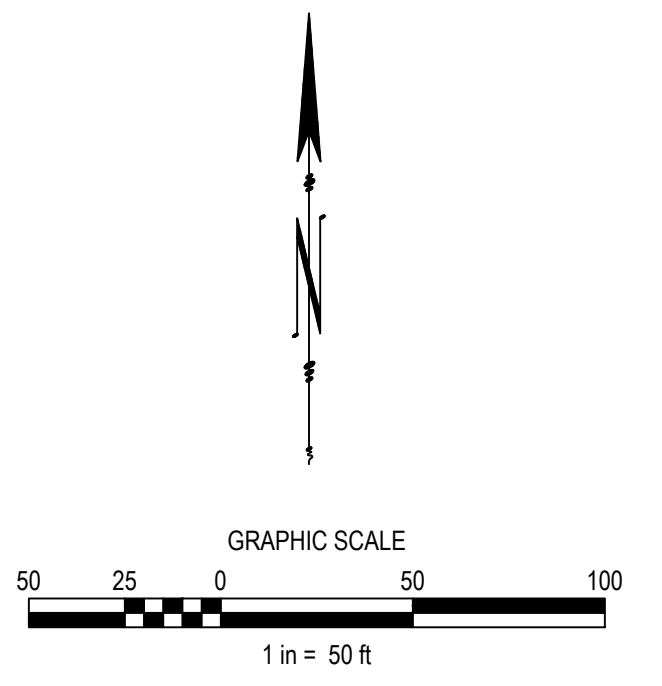
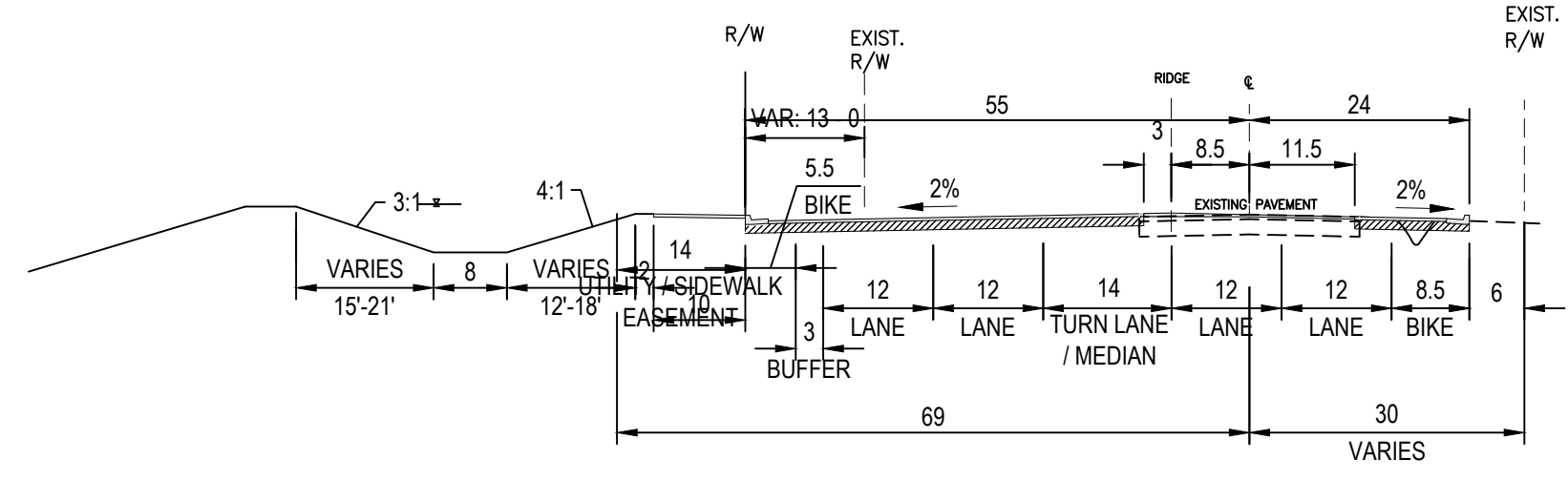
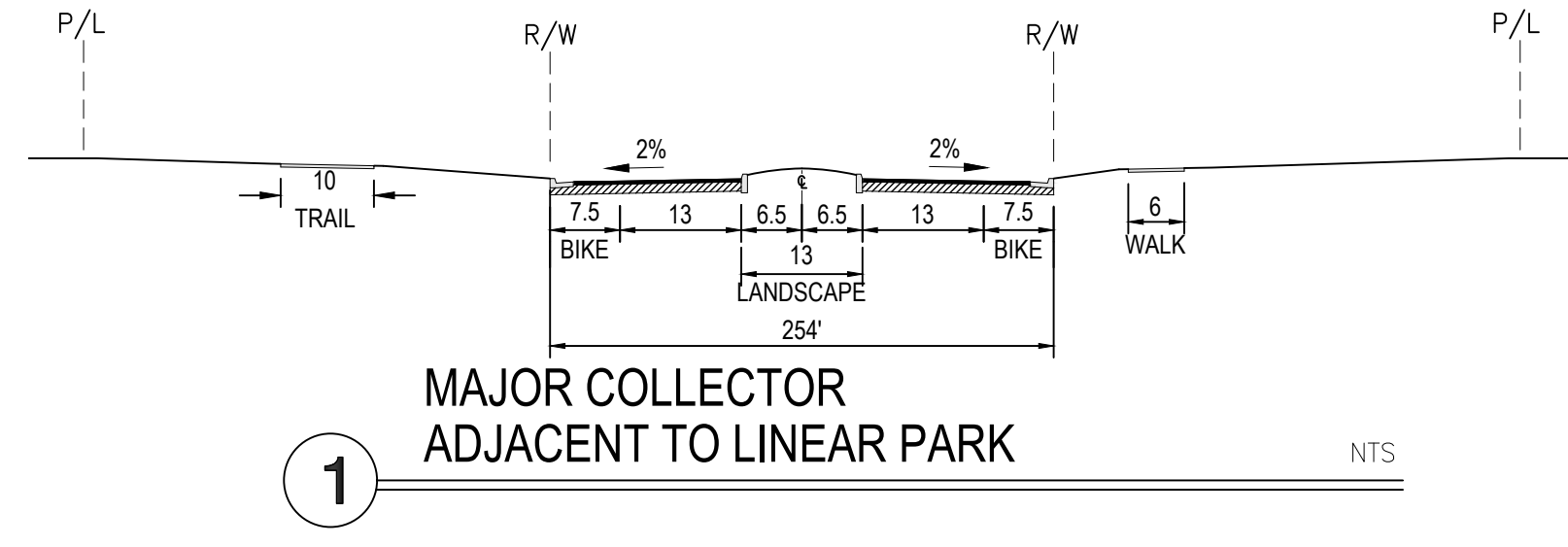

SCALE: 1" = 50'	BENCH MARK 7/8" METAL DISC STAMPED "00, BM, 19-25" (LOCATED IN TOP OF S.E. END OF S.W. CONCRETE HEADWALL OF CULVERT ACROSS THE SPRR, 5 PACES S.W. OF CENTER OF TRACKS, APPROXIMATELY 50' N.E. OF CENTER OF PLACERVILLE ROAD, N.E. OF OLD STATE CULVERT APR-50, 15 PACES N.W. OF MILEPOST 119.2, APPROXIMATELY 0.45 MILES N.W. OF U.S. ROUTE 50 (R.R. CULVERT BUILT IN 1916))
HORIZ. 1" =	
VERT. 1" =	

COMPUTED
DESIGNED
DRAWN
PROJ. ENGR.

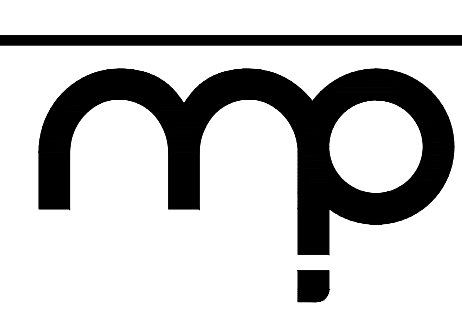

**MORTON & PITALO, INC.**  
CIVIL ENGINEERING • LAND PLANNING • LAND SURVEYING  
Folsom • Fresno  
600 Coolidge Drive, Suite #140  
Folsom, CA 95630  
phone: (916) 964-7621  
web: www.mpegr.com

THE CAMPUS @ DIXON  
VILLAGE 2 - PRELIMINARY GRADING

DATE	3/11/2025
SHEET	PG-2
OF	8



SEE SHEET PG-8

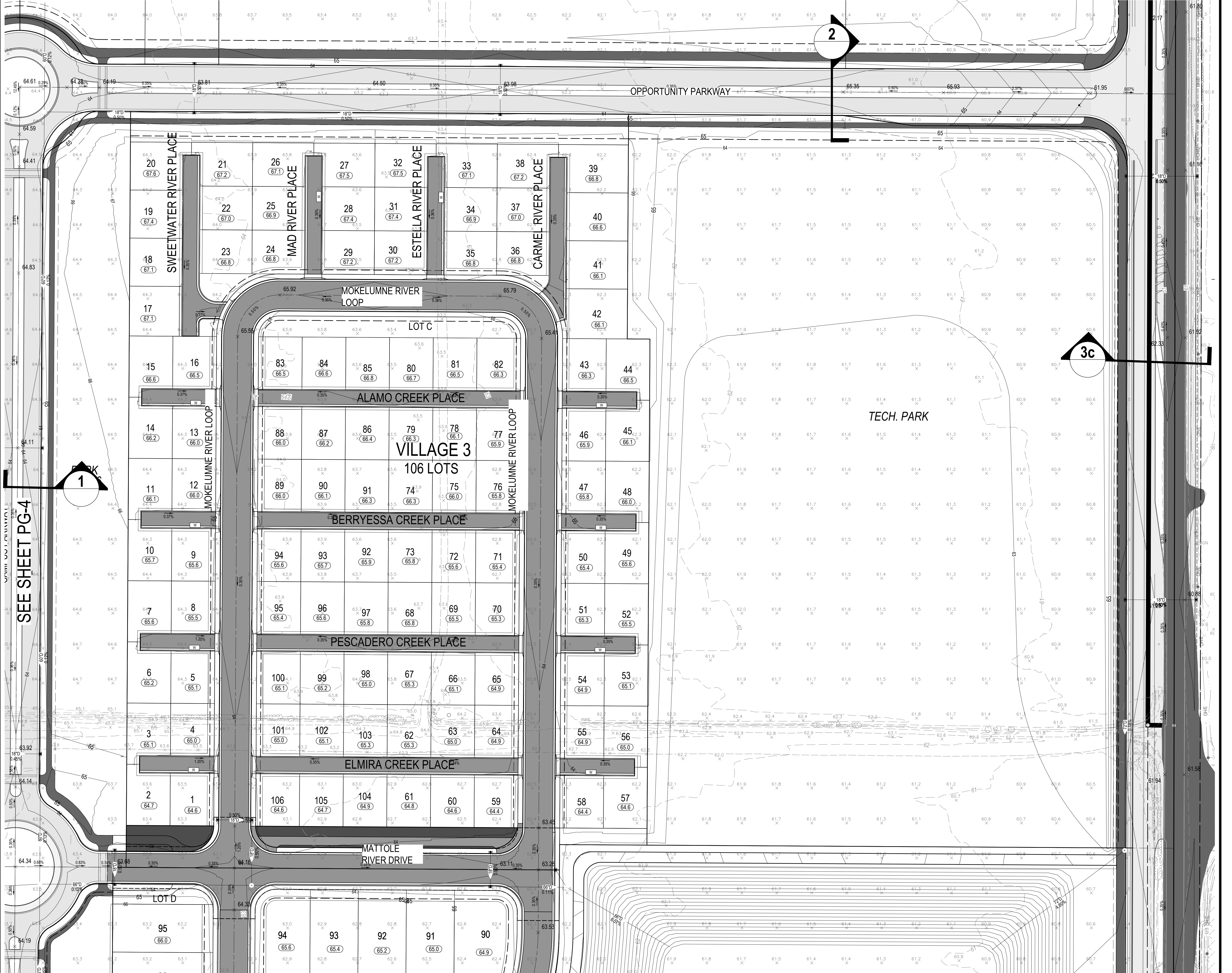

VILLAGE 2  
SEE SHEET PG-2

**LEGEND**

SYMBOLS:	EXISTING	PROPOSED	DESCRIPTION
			STORM DRAIN PIPE & SIZE
			MANHOLE
			STORM DRAIN INLET
			RIDGE OR GRADE BREAK
			DIRECTION OF DRAINAGE
			FLOWLINE OF SWALE

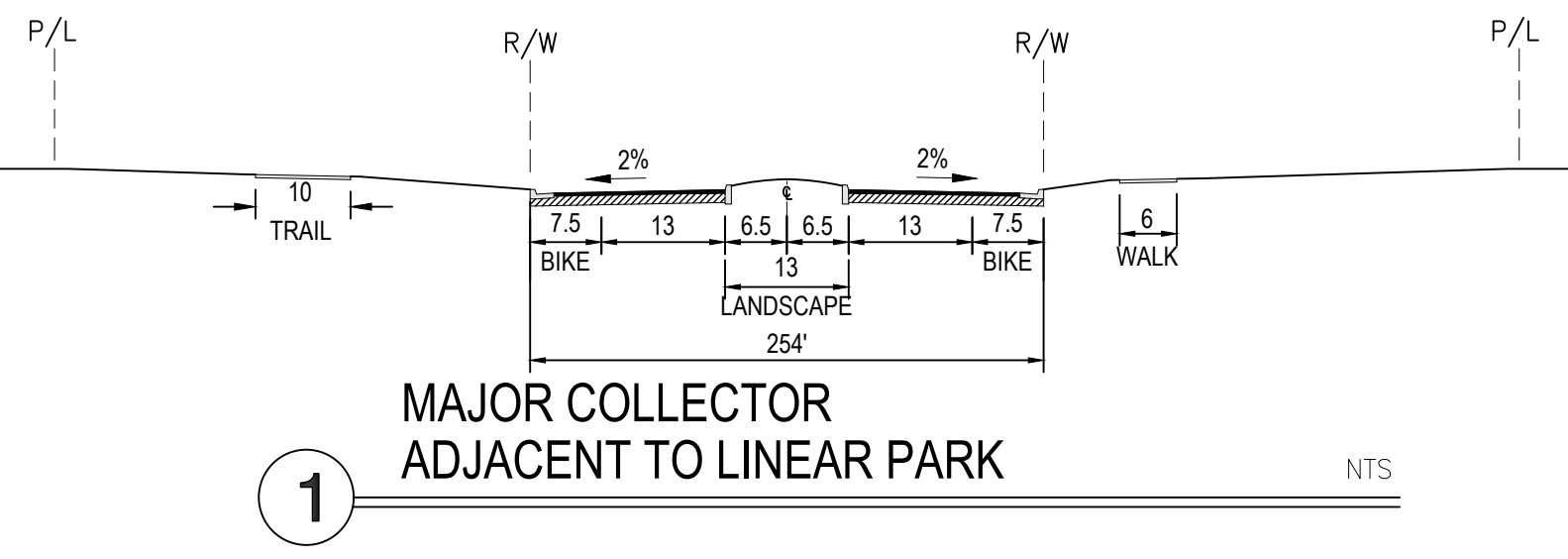

1

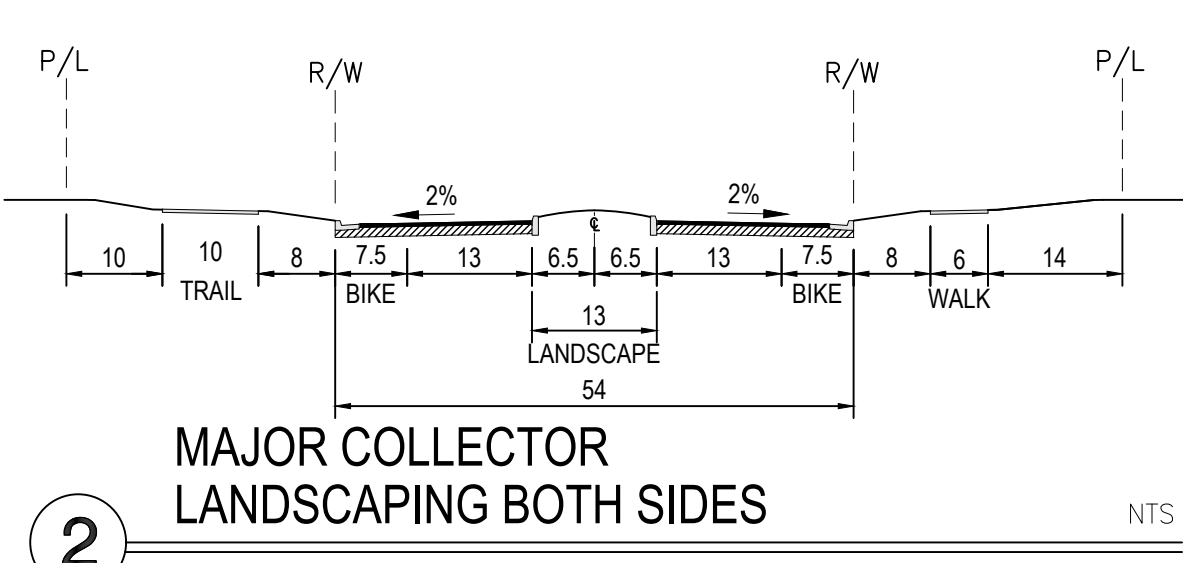

2

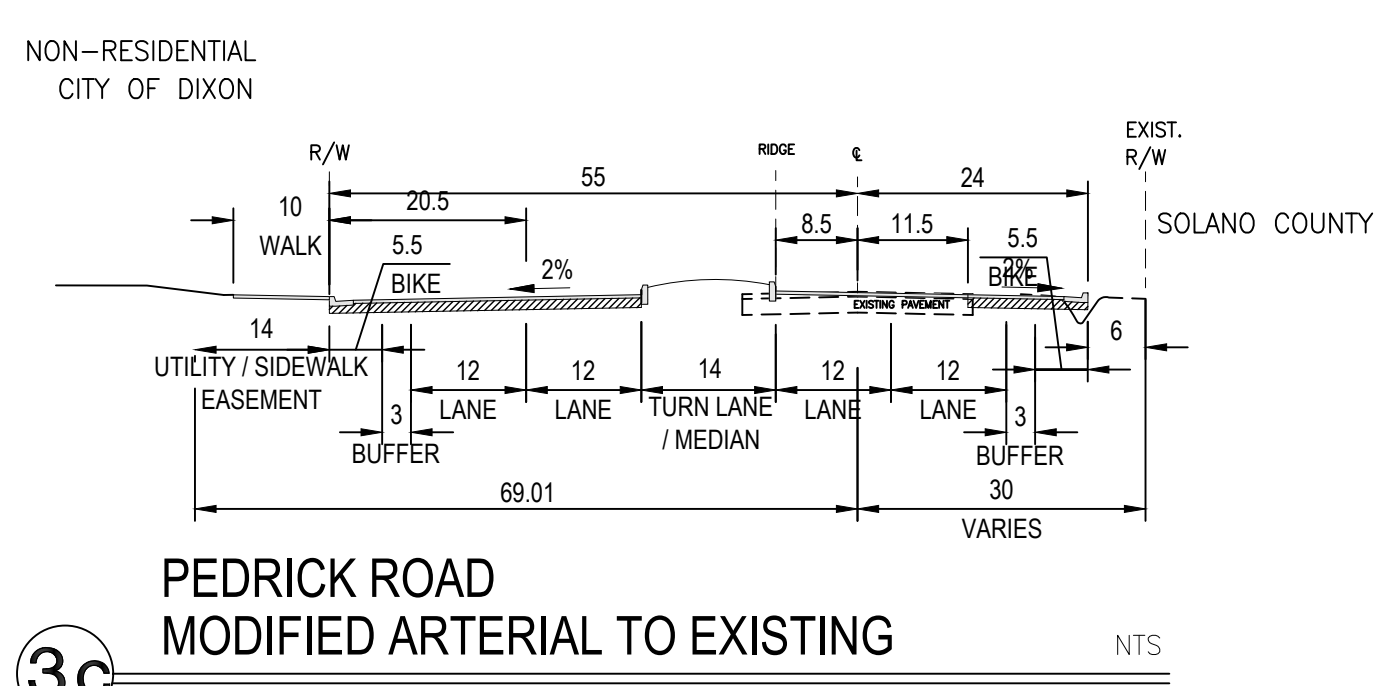

3c

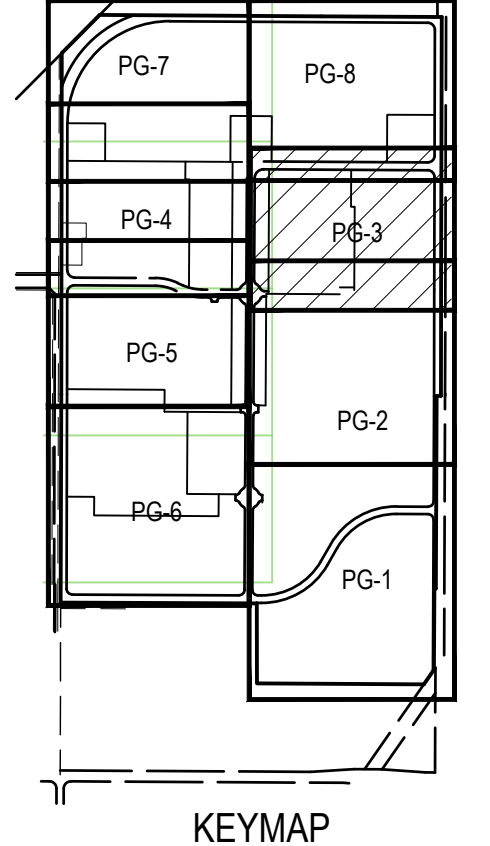
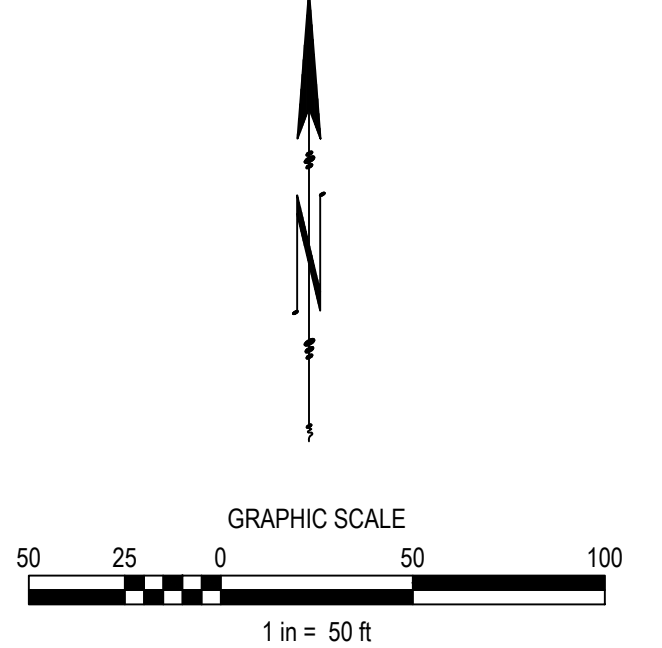

SCALE: 1" = 50'	BENCH MARK 7/8" METAL DISC STAMPED "00, BM, 19-35" (LOCATED IN TOP OF S.E. END OF S.W. CONCRETE HEADWALL OF CULVERT ACROSS THE SPUR, 5 APPROXIMATELY 50' N.E. OF CENTER OF PLACERVILLE ROAD, N.E. OF OLD STATE CULVERT APPROXIMATELY 35 PAGES N.W. OF MILEPOST 118 & APPROXIMATELY 0.45 MILES N.W. OF U.S. ROUTE 50 (R.R. CULVERT BUILT IN 1916))
HORIZ. 1" =	
VERT. 1" =	

COMPUTED
DESIGNED
DRAWN
PROJ. ENGR.

**mp** **MORTON & PITALO, INC.**  
CIVIL ENGINEERING • LAND PLANNING • LAND SURVEYING  
Folsom • Fresno  
600 Coolidge Drive, Suite #140  
Folsom, CA 95630  
phone: (916) 964-7621  
web: www.mppengr.com

THE CAMPUS @ DIXON  
VILLAGE 3 - PRELIMINARY GRADING

DATE	3/11/2025
SHEET	PG0-3
OF	8



SEE SHEET PG-7



VILLAGE 6  
SEE SHEET PG-5

**LEGEND**

EXISTING	PROPOSED	DESCRIPTION
		STORM DRAIN PIPE & SIZE
		MANHOLE
		STORM DRAIN INLET
		RIDGE OR GRADE BREAK
		DIRECTION OF DRAINAGE
		FLOWLINE OF SWALE

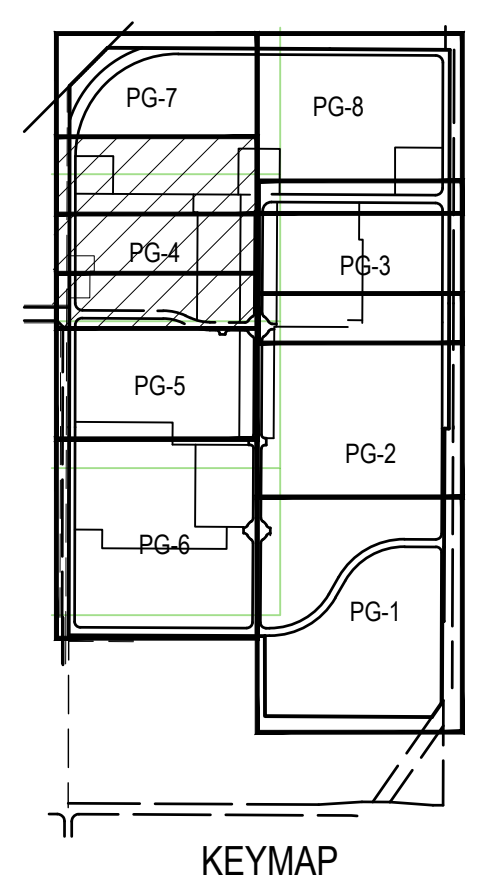
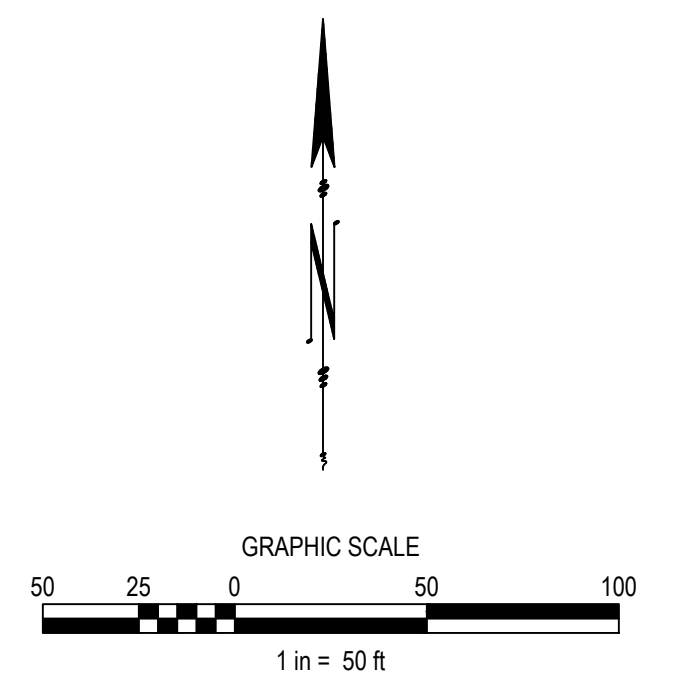
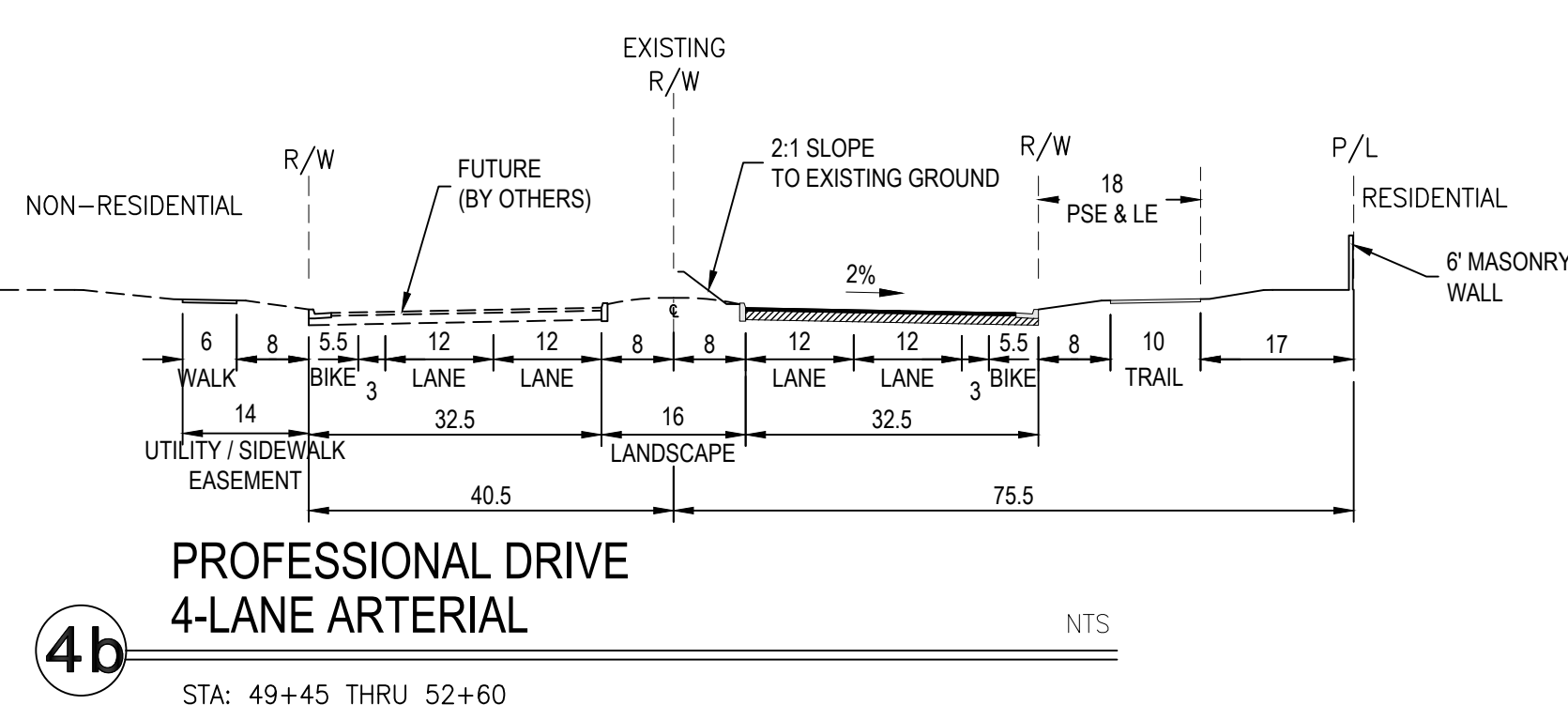
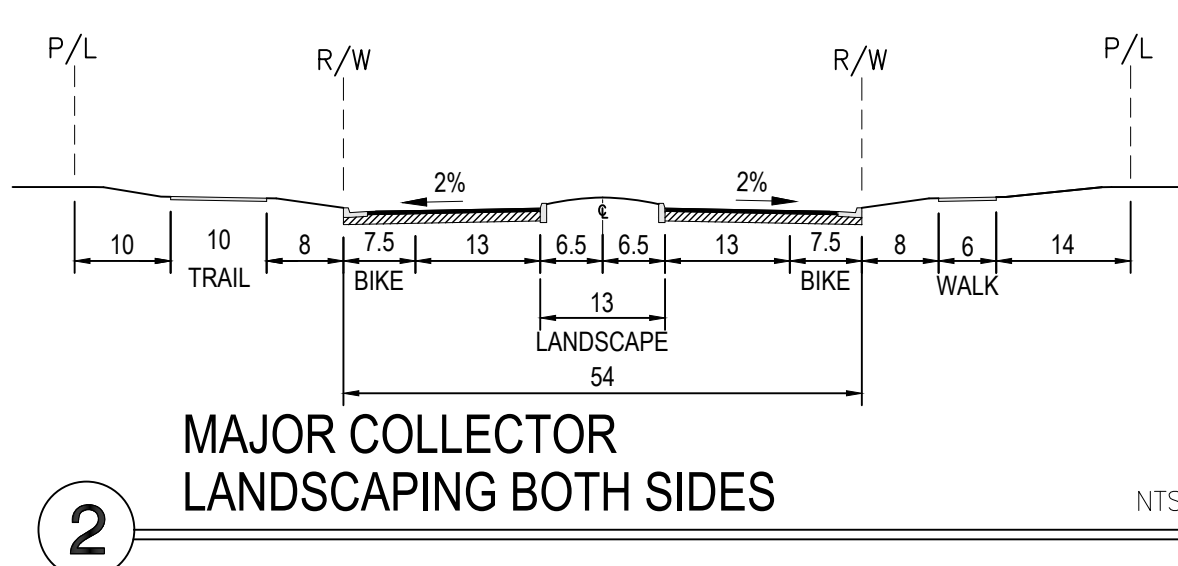
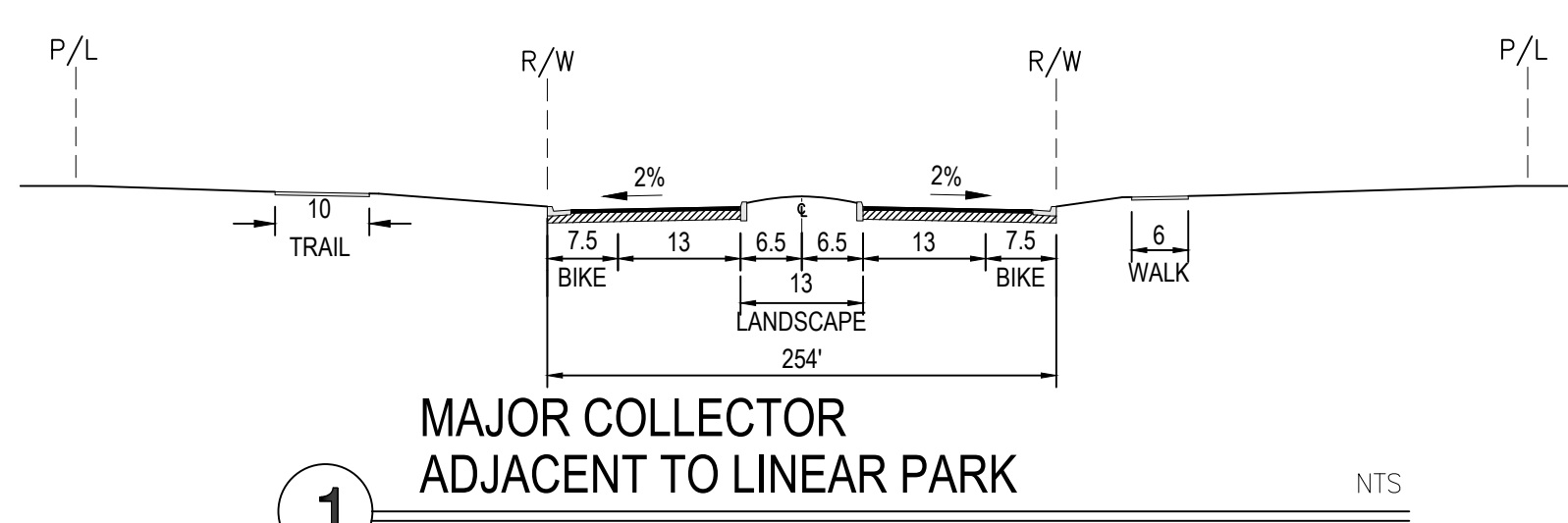

SCALE: 1" = 50'  
BENCH MARK: 7/8" METAL DISC STAMPED "00, R.M. 18-35" LOCATED IN TOP OF SE END OF SW CONCRETE HEADWALL OF CULVERT ACROSS THE SPRING, APPROXIMATELY 50' N.E. OF CENTER OF PLAZAVILLE ROAD, N.E. OF OLD STATE CULVERT APPROXIMATELY 36' PACE S.W. OF MILEPOST 118.2, APPROXIMATELY 0.45 MILES N.W. OF U.S. ROUTE 50 (R.R. CULVERT BUILT IN 1916)

COMPUTED  
DESIGNED  
DRAWN  
PROJ. ENGR.

THE CAMPUS @ DIXON  
VILLAGE 4 & 5 - PRELIMINARY GRADING

DATE: 3/11/2025  
SHEET: PG-4  
OF: 8



VILLAGE 4 & 5  
SEE SHEET PG-4



VILLAGE 7 & 8  
SEE SHEET PG-6

LEGEND

SYMBOLS:		DESCRIPTION
EXISTING	PROPOSED	
		STORM DRAIN PIPE & SIZE
		MANHOLE
		STORM DRAIN INLET
		RIDGE OR GRADE BREAK
		DIRECTION OF DRAINAGE
		FLOWLINE OF SWALE

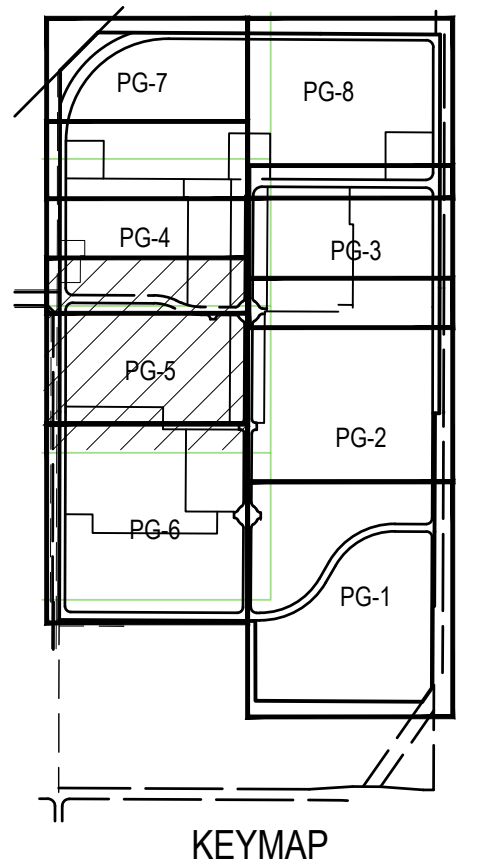
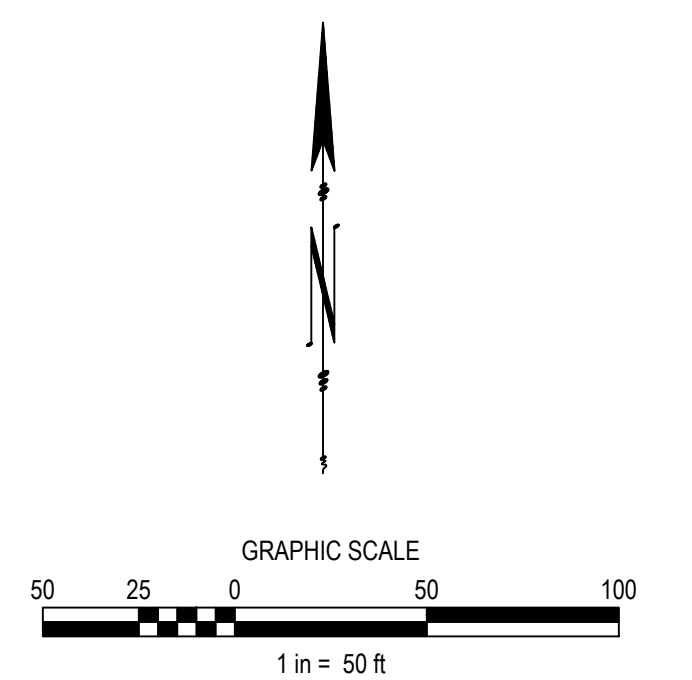
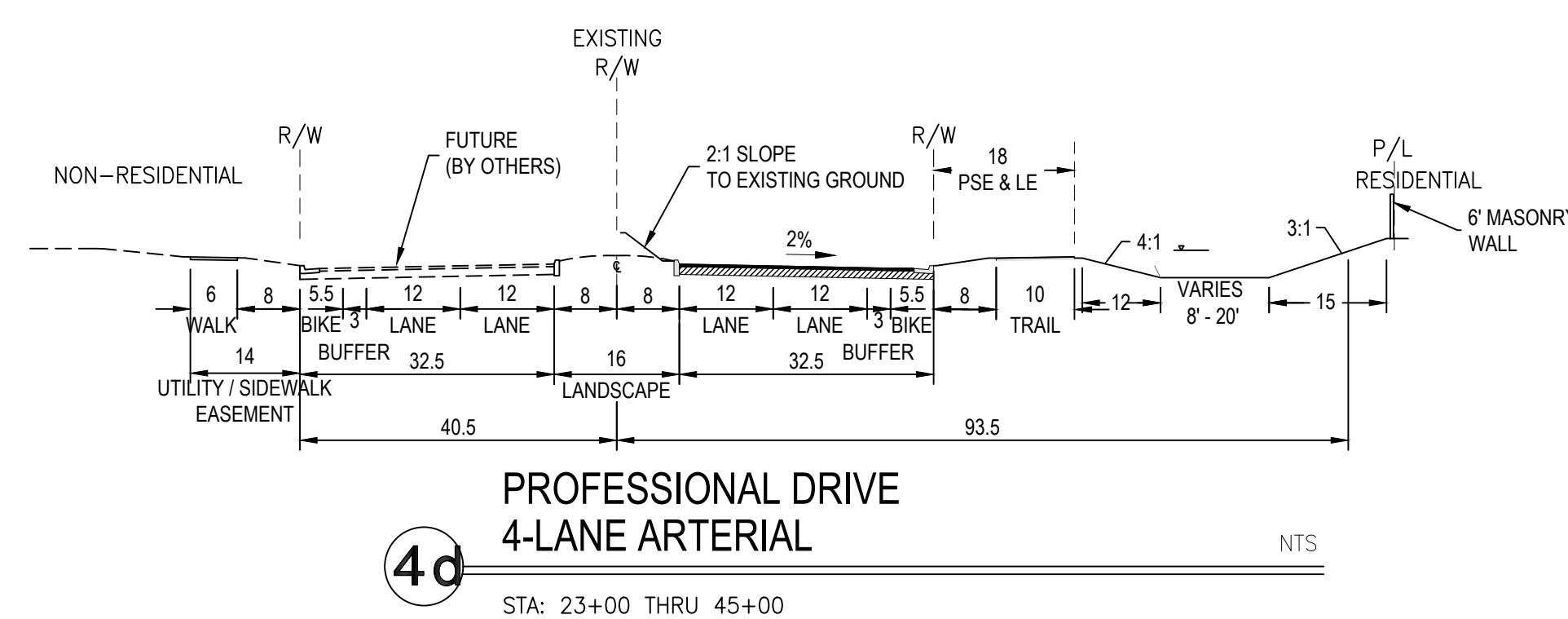
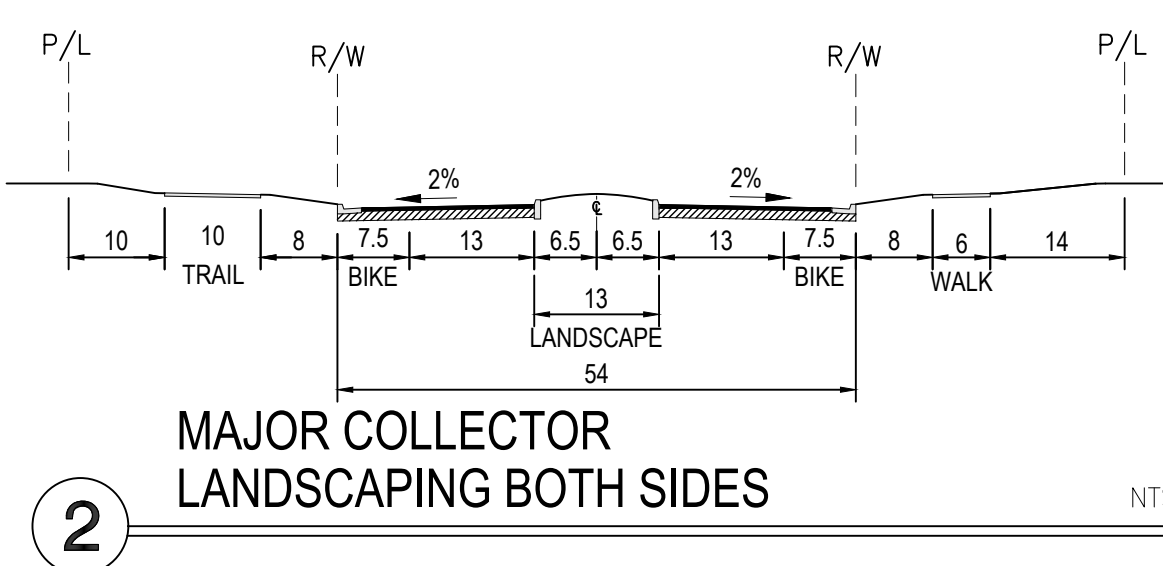
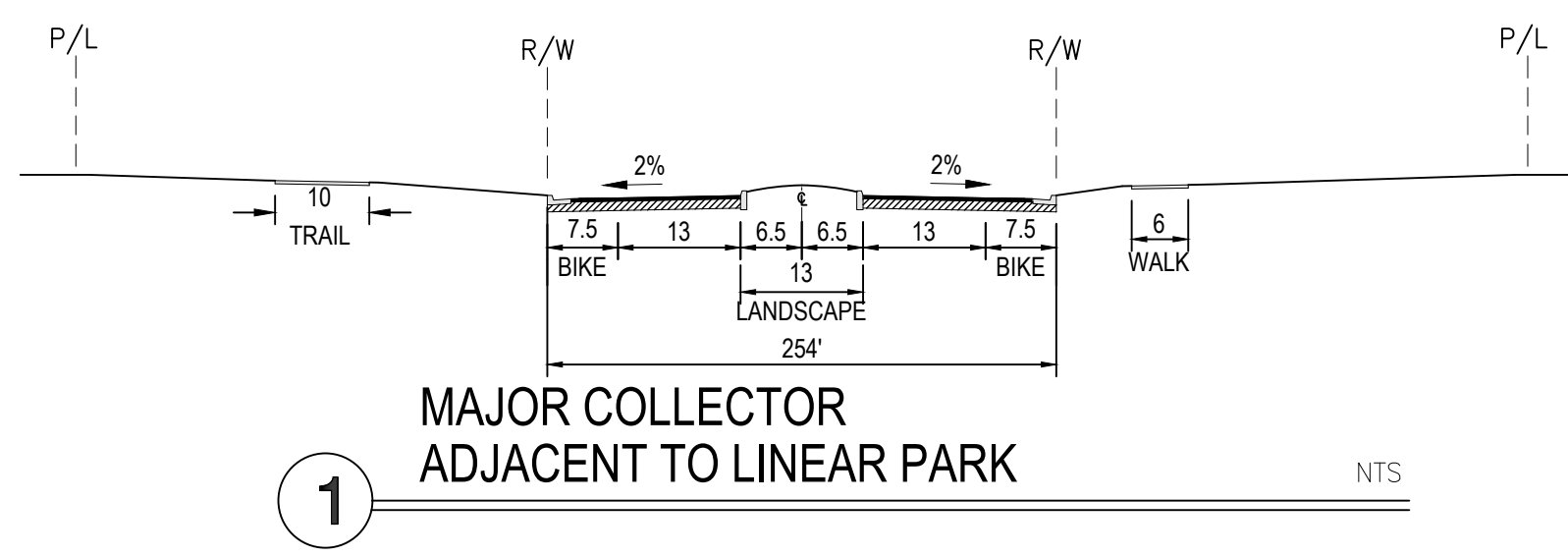

SCALE: 1" = 50'  
HORIZ. 1" =  
VERT. 1" =

**BENCH MARK**  
7/8" METAL DISC STAMPED "00, 0.0, 19-35"  
(LOCATED IN TOP OF S.E. END OF S.W. CONCRETE  
HEADWALL OF CULVERT ACROSS THE SPRAY, S  
APPROXIMATELY 50' N.E. OF CENTER OF  
PLACERVILLE ROAD, N.E. OF OLD STATE CULVERT  
APR-50, 35 PAGES N.W. OF MILEPOST 119.4  
APPROXIMATELY 0.45 MILES N.W. OF U.S. ROUTE 50  
(R.R. CULVERT BUILT IN 1916)

COMPUTED  
DESIGNED  
DRAWN  
PROJ. ENGR.

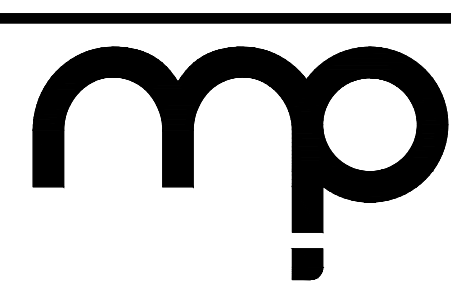

**MORTON & PITALO, INC.**  
CIVIL ENGINEERING • LAND PLANNING • LAND SURVEYING  
Folsom • Fresno  
600 Coolidge Drive, Suite #140  
Folsom, CA 95630  
phone: (916) 964-7621  
web: www.mpegr.com

MAGNA PARCEL-DIXON  
VILLAGE 6 - PRELIMINARY GRADING

DATE  
3/11/2025  
SHEET  
PG-5  
OF  
8



VILLAGE 6  
SEE SHEET PG-5

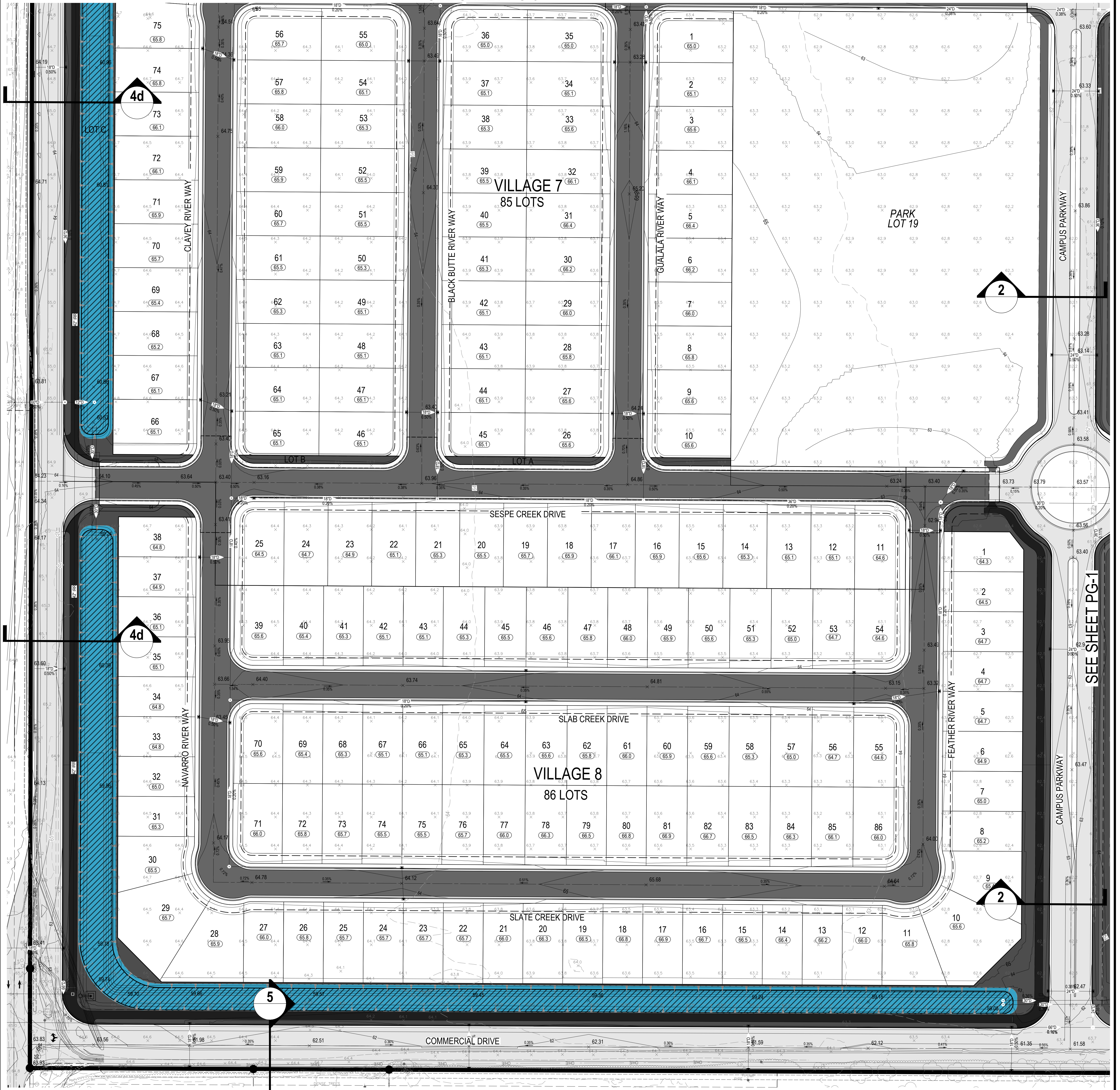

LEGEND

SYMBOLS:	PROPOSED	DESCRIPTION
		STORM DRAIN PIPE & SIZE
		MANHOLE
		STORM DRAIN INLET
		RIDGE OR GRADE BREAK
		DIRECTION OF DRAINAGE
		FLOWLINE OF SWALE

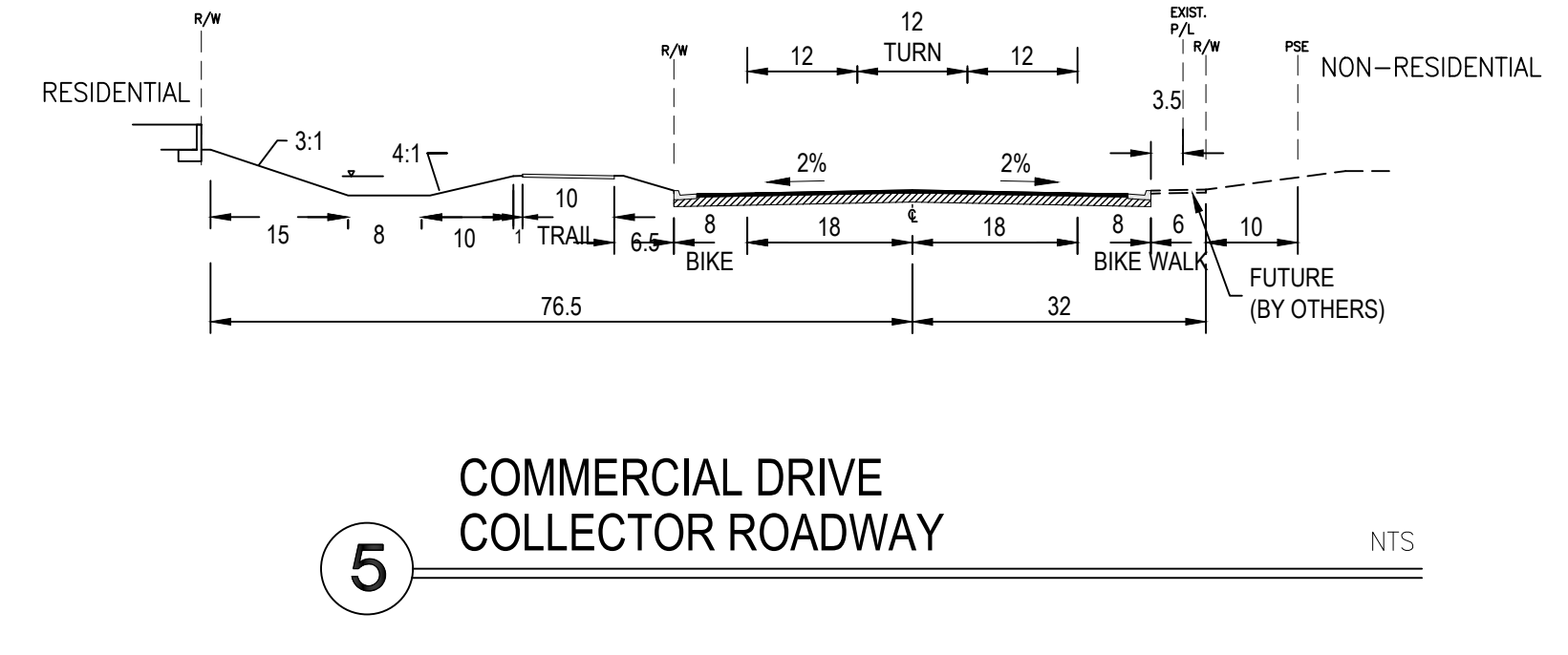
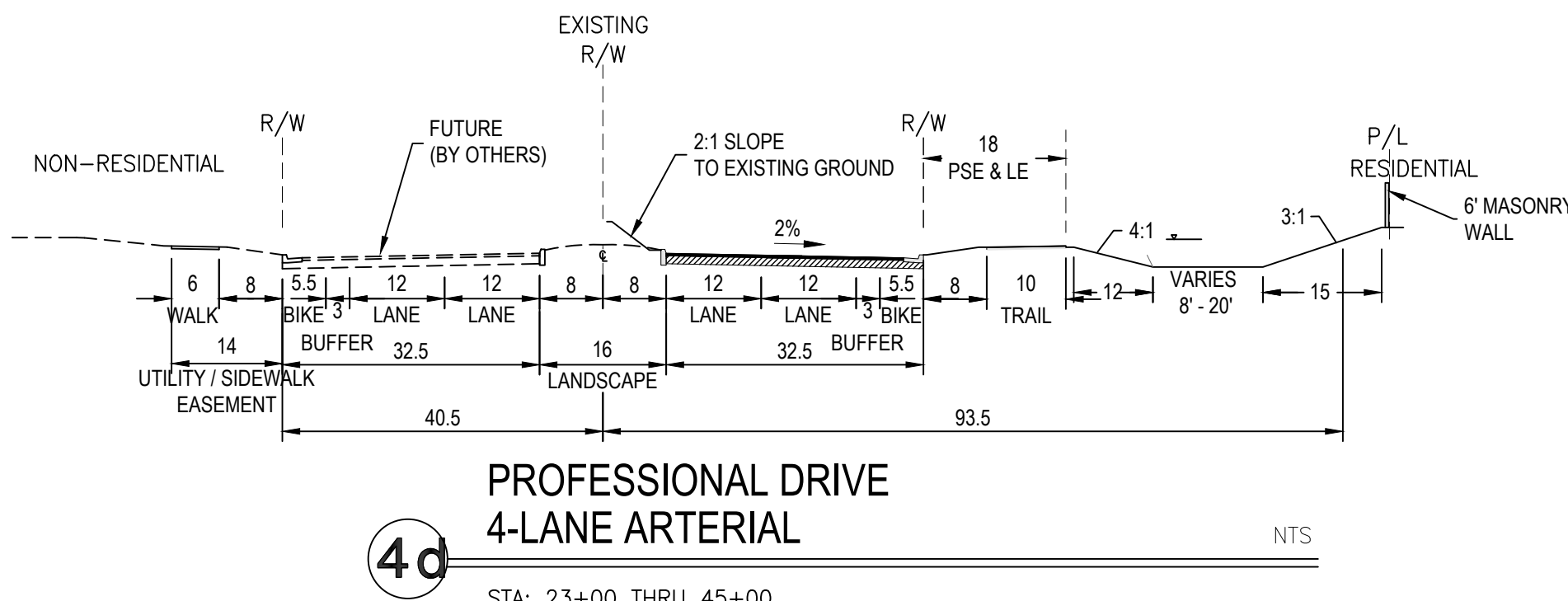
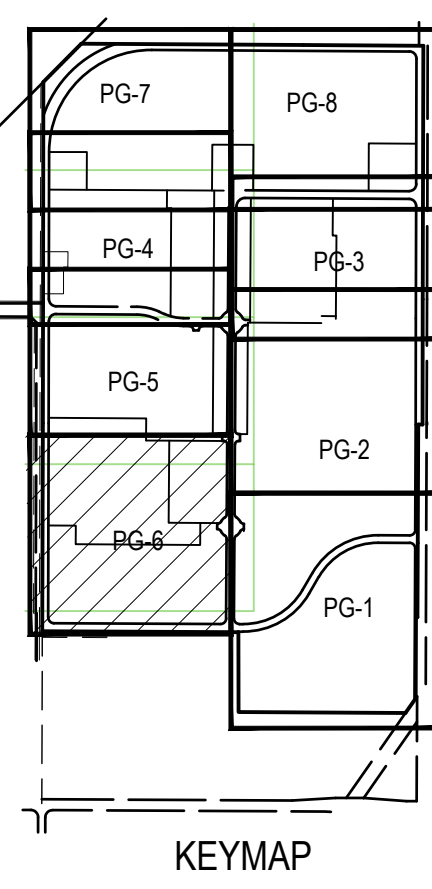
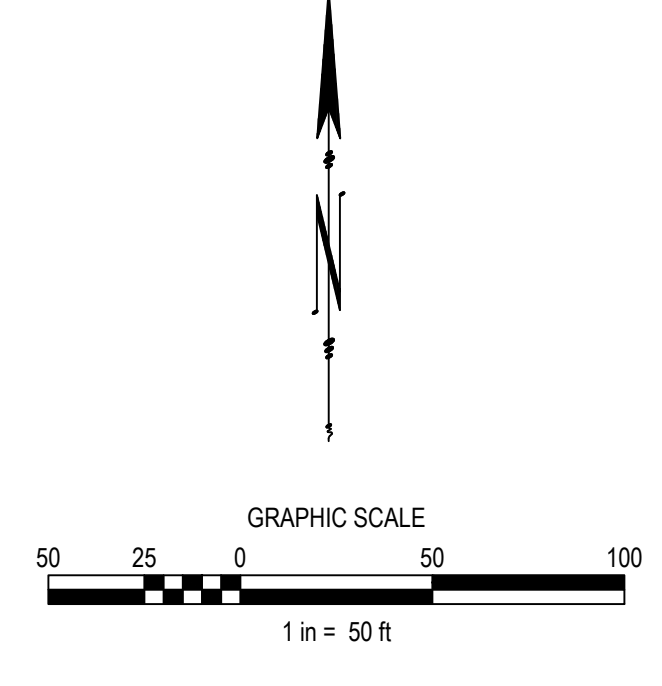
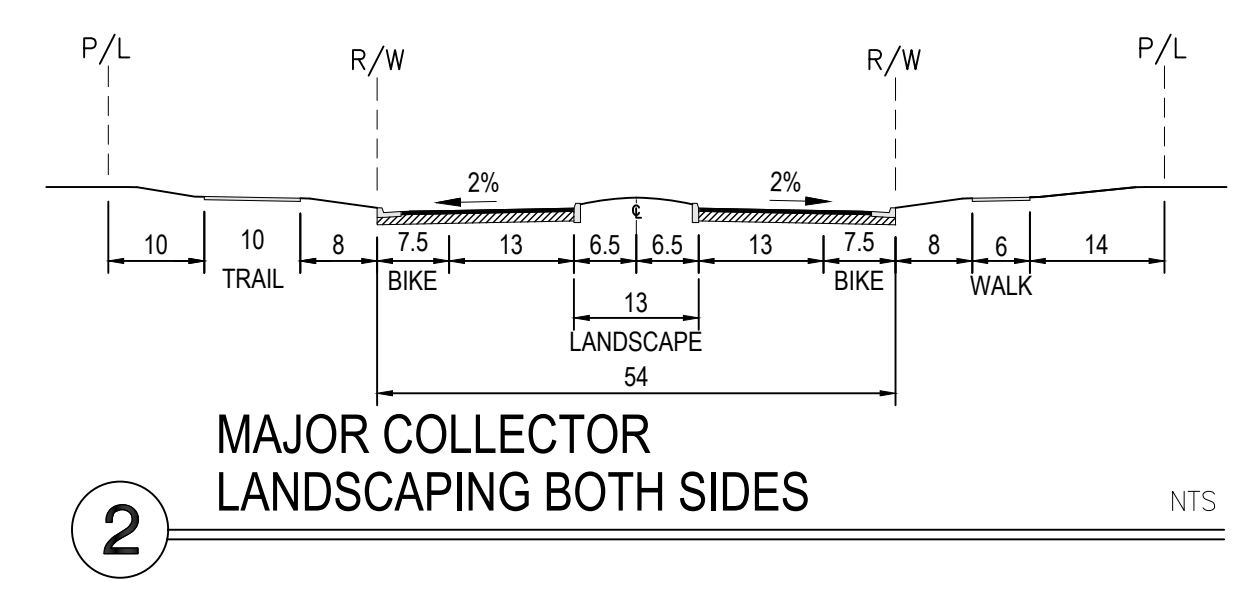

SCALE: 1" = 50'  
HORIZ. 1" =  
VERT. 1" =

BENCH MARK  
7" x 7" METAL DISC STAMPED "00, 0.0M, 10-25"  
(LOCATED IN TOP OF S.E. END OF S.W. CONCRETE  
NEIGHBORLY OF CULVERT ACROSS THE SPRR, 5  
APPROXIMATELY 50' N.W. OF CENTER OF  
PLACERVILLE ROAD, N.E. OF OLD STATE CULVERT  
APPROXIMATELY 15' PACE S.W. OF MILEPOST 119.2  
APPROXIMATELY 0.45 MILES N.W. OF U.S. ROUTE 50  
(R.R. CULVERT BUILT IN 1916)

COMPUTED  
DESIGNED  
DRAWN  
PROJ. ENGR.

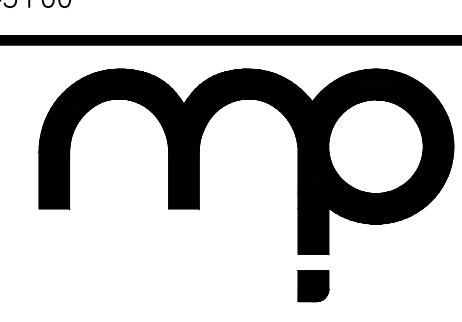

**MORTON & PITALO, INC.**  
CIVIL ENGINEERING • LAND PLANNING • LAND SURVEYING  
Folsom • Fresno  
600 Coolidge Drive, Suite #140  
Folsom, CA 95630  
Phone: (916) 964-7621  
www.mppengr.com

MAGNA PARCEL-DIXON  
VILLAGE 7 & 8 - PRELIMINARY GRADING

DATE  
3/11/2025  
SHEET  
PG-6  
OF  
8







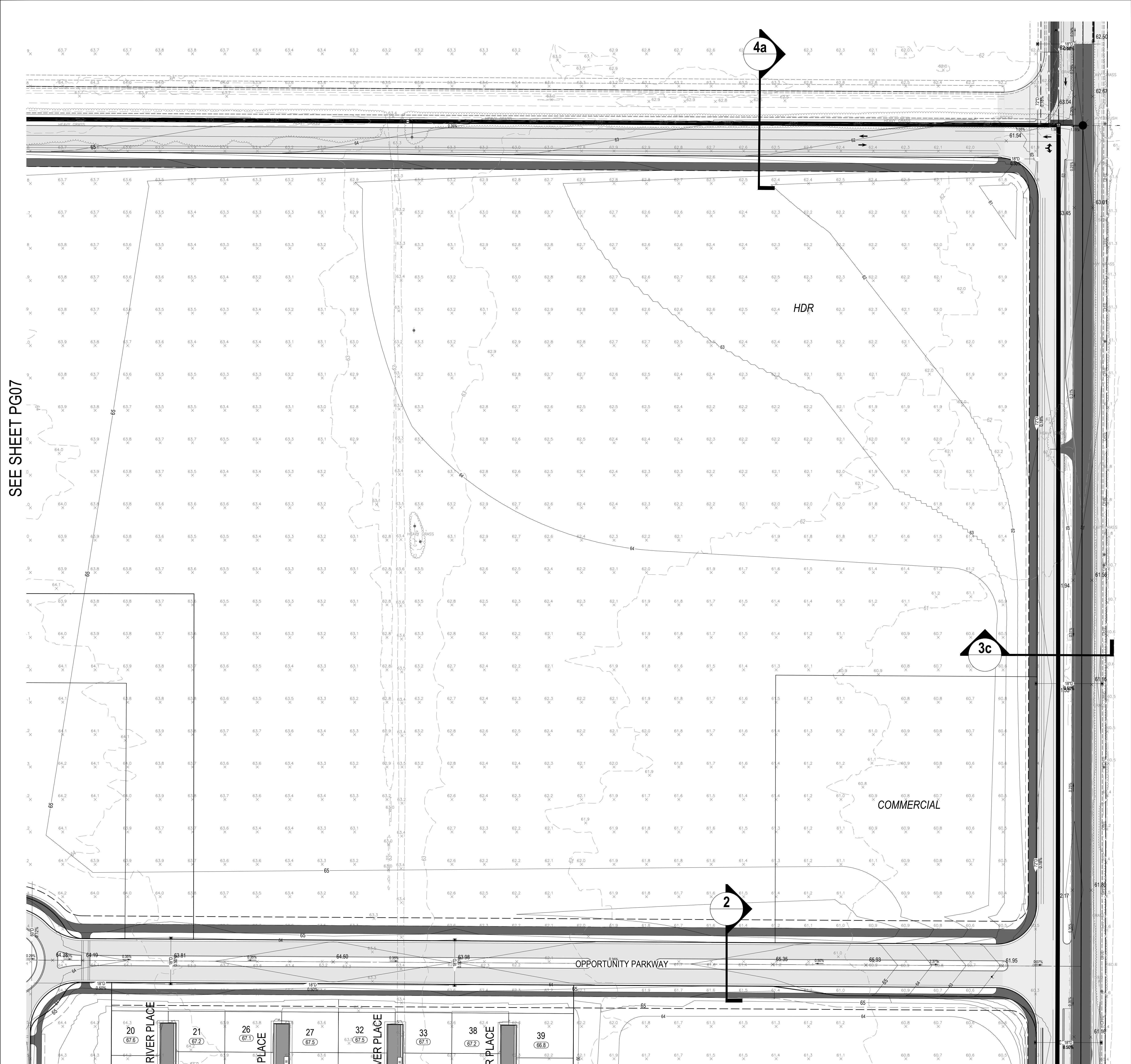

SEE SHEET PG07

VILLAGE 3  
SEE SHEET PG04

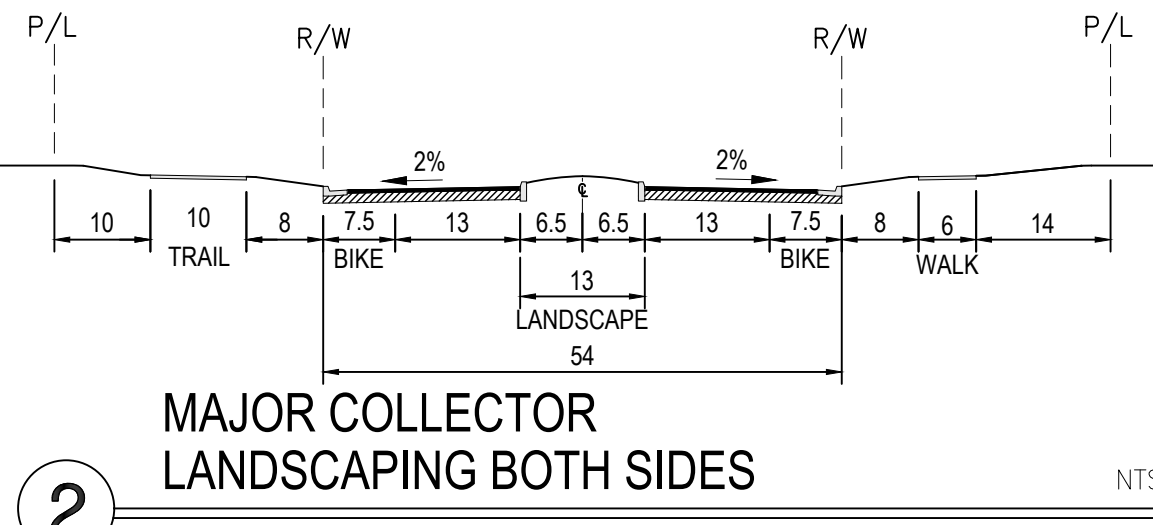

2  
MAJOR COLLECTOR  
LANDSCAPING BOTH SIDES  
NTS

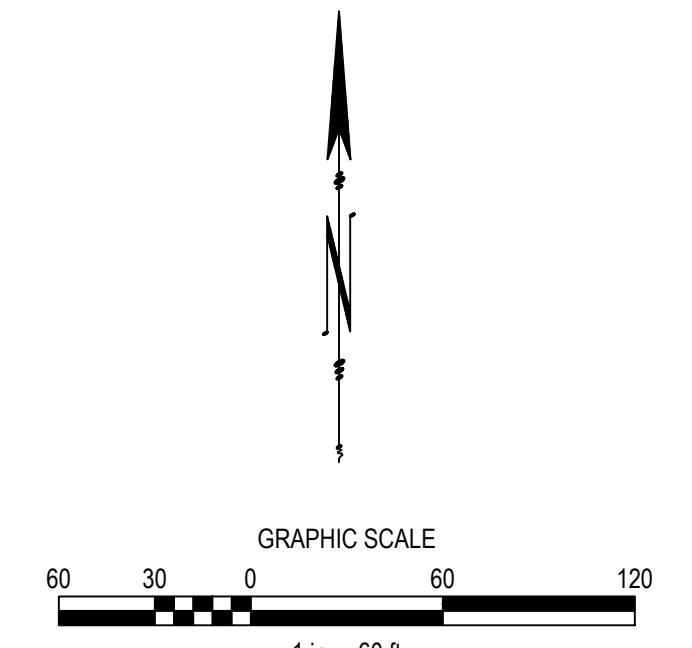

**SYMBOLS:**

EXISTING	PROPOSED	DESCRIPTION
		STORM DRAIN PIPE & SIZE
		MANHOLE
		STORM DRAIN INLET
		RIDGE OR GRADE BREAK
		DIRECTION OF DRAINAGE
		FLOWLINE OF SWALE

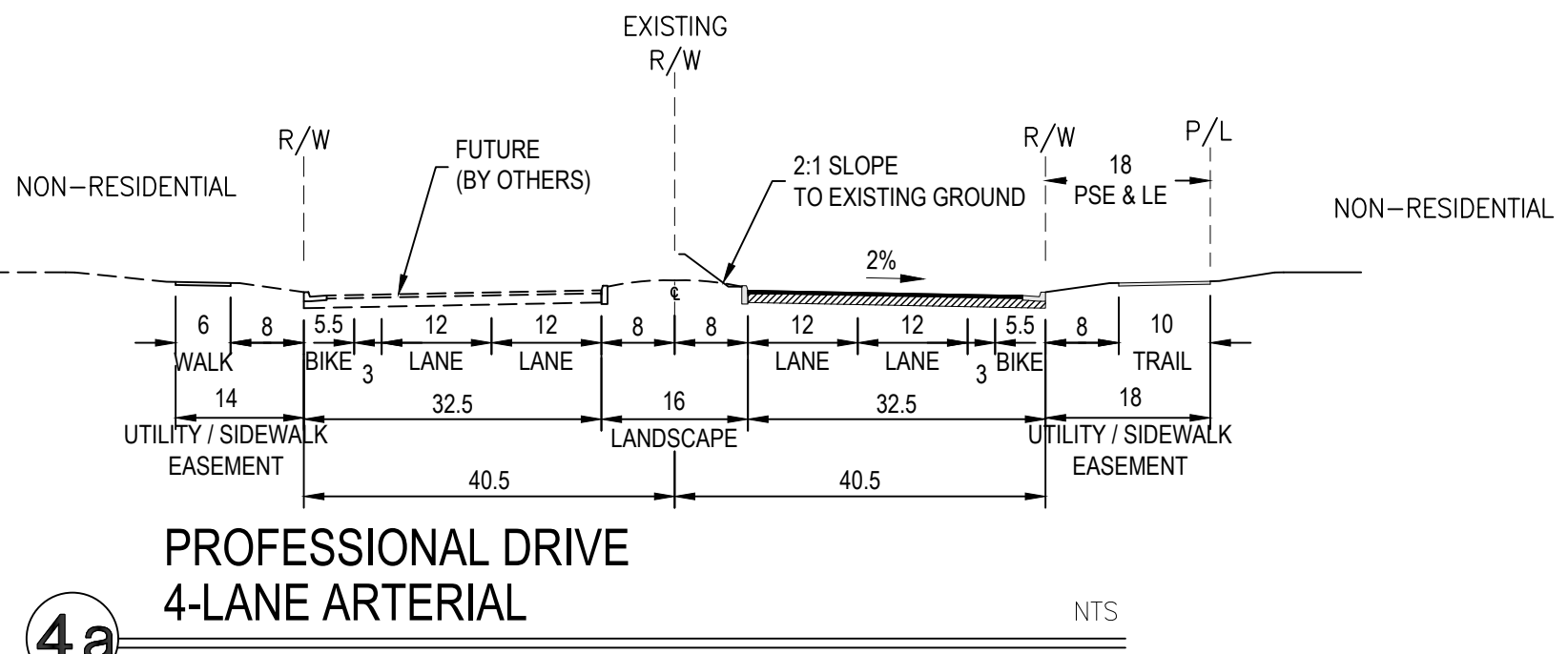

4a  
PROFESSIONAL DRIVE  
4-LANE ARTERIAL  
NTS  
STA: 45+00 THRU 49+45

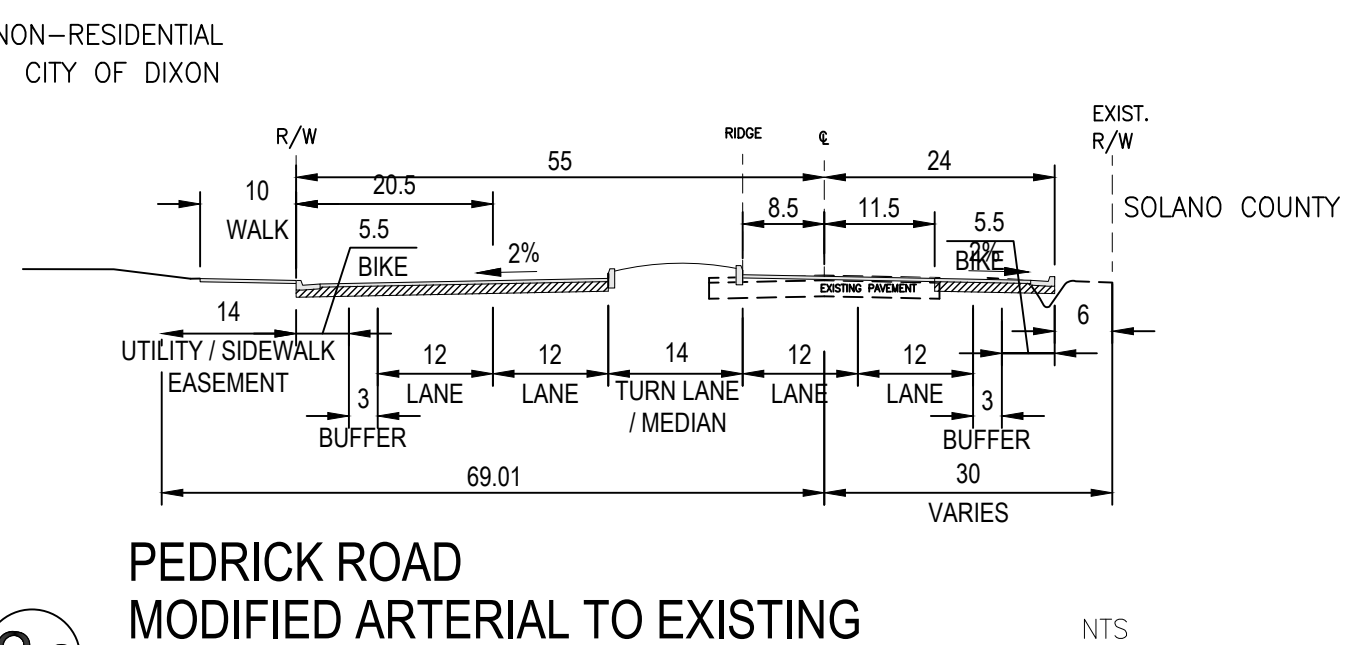

3c  
PEDRICK ROAD  
MODIFIED ARTERIAL TO EXISTING  
NTS

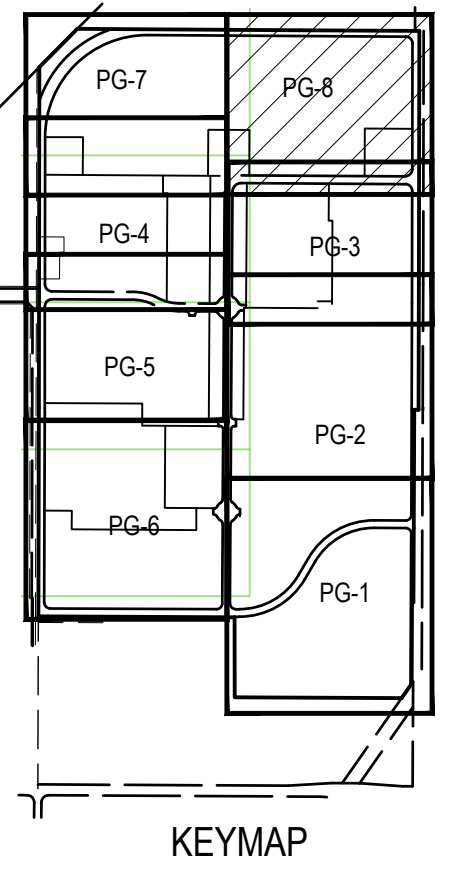

**SCALE:** 1" = 60'

**BENCH MARK:** 7/8" METAL DISC-STAMPED "00, D.M. 19-35" (LOCATED IN TOP OF S.E. END OF S.W. CONCRETE HEADWALL OF CULVERT ACROSS THE SPR, 5 PACES S.W. OF CENTER OF TRACKS, APPROXIMATELY 50' N.E. OF CENTER OF PLACERVILLE ROAD, N.E. OF OLD STATE CULVERT APPROXIMATELY 15 PACES N.W. OF MILEPOST 118.2, APPROXIMATELY 0.45 MILES N.W. OF U.S. ROUTE 50 (R.R. CULVERT BUILT IN 1916))

COMPUTED
DESIGNED
DRAWN
PROJ. ENGR.



**MORTON & PITALO, INC.**  
CIVIL ENGINEERING • LAND PLANNING • LAND SURVEYING  
Folsom • Fresno  
600 Coolidge Drive, Suite #140  
Folsom, CA 95630  
phone: (916) 964-7621  
web: www.mpegr.com

**THE CAMPUS @ DIXON**  
MIXED USE - PRELIMINARY GRADING

DATE	3/11/2025
SHEET	PG-8
OF	8